

产品规格书

Specification of Products

产品名称：可控硅模块

产品型号：MTC110A

浙江世菱电力电子有限公司

ZHEJIANG SHILING POWER ELECTRON CO.,LTD.

厂址：浙江省 缙云县 五东工业区

电话：（0578）3012571 3615078

传真：（0578）3611180

邮编：321400

E-mail: smrshiling01@163.com

Http://www.smrshiling.com

拟制	审核	核准
金明辉	曹剑龙	宗瑞

Rating and Characteristic

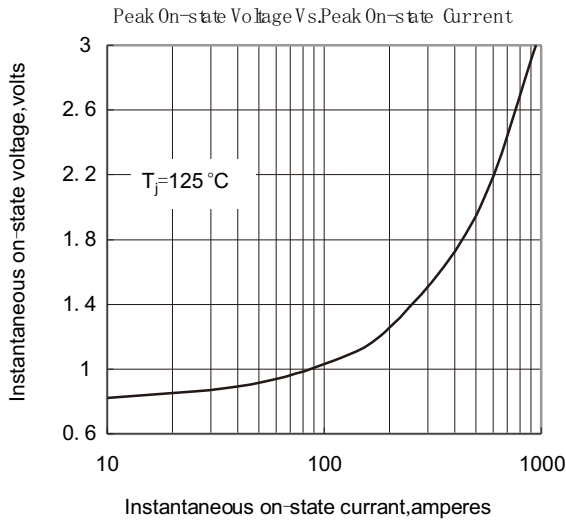

Fig. 1

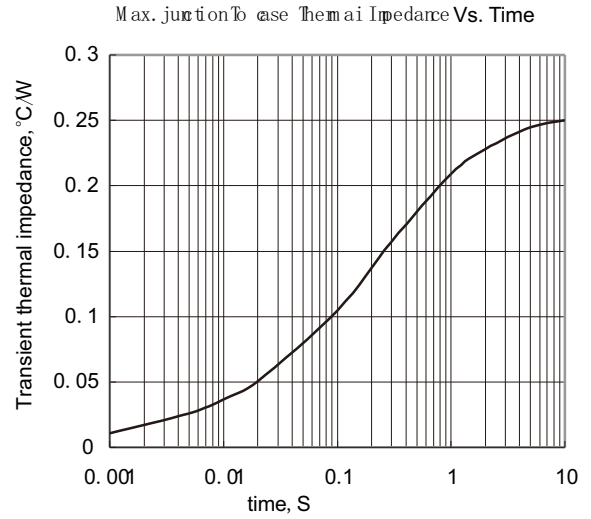

Fig. 2

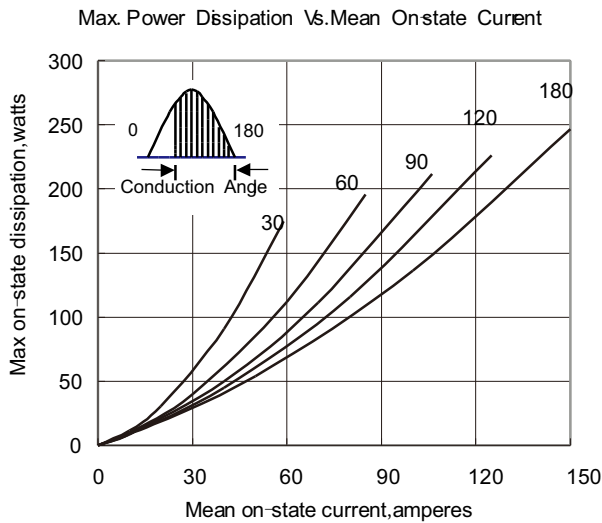

Fig. 3

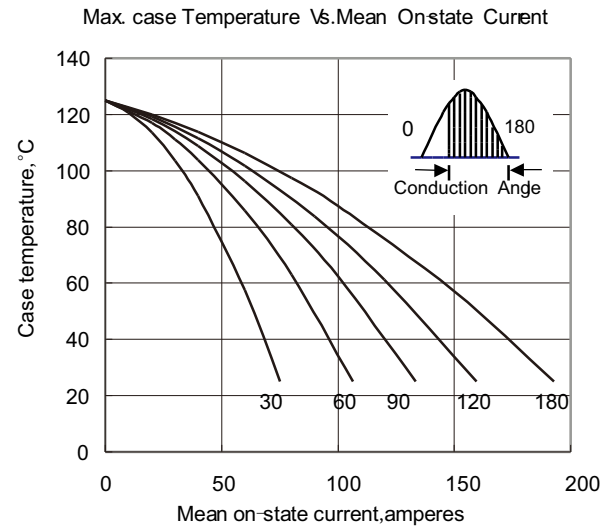

Fig. 4

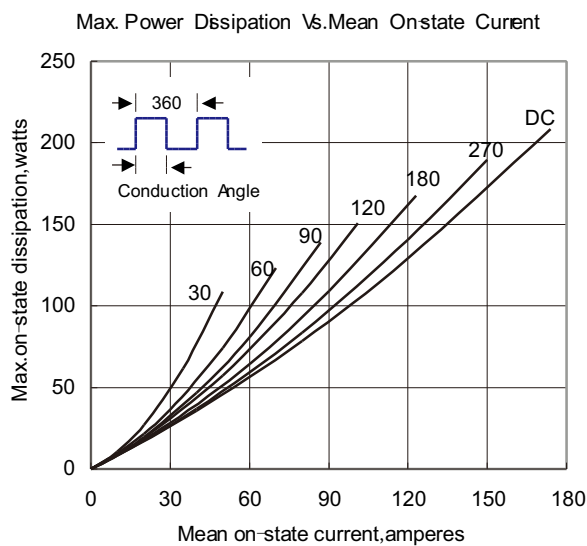

Fig. 5

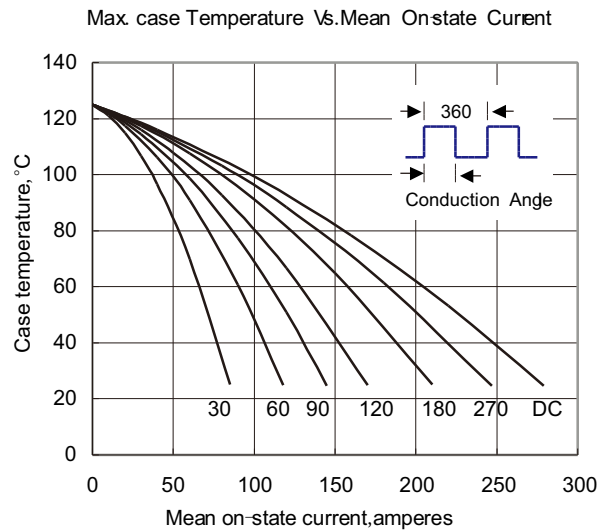

Fig. 6

Rating and Characteristic

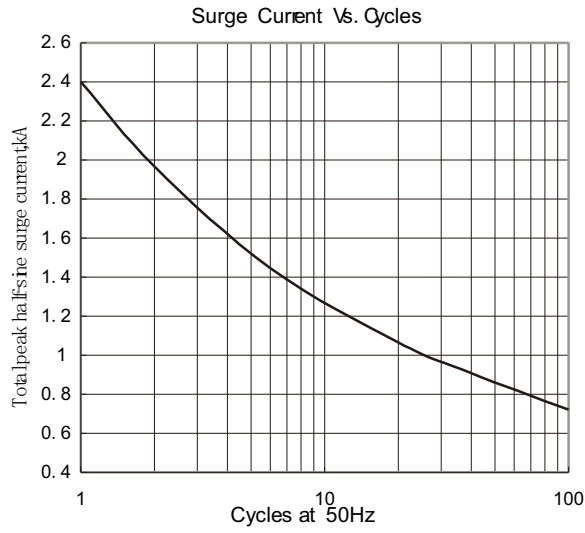

Fig. 7

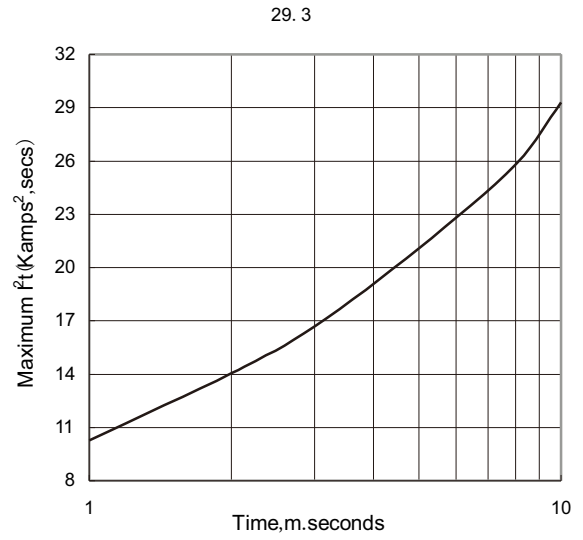

Fig. 8

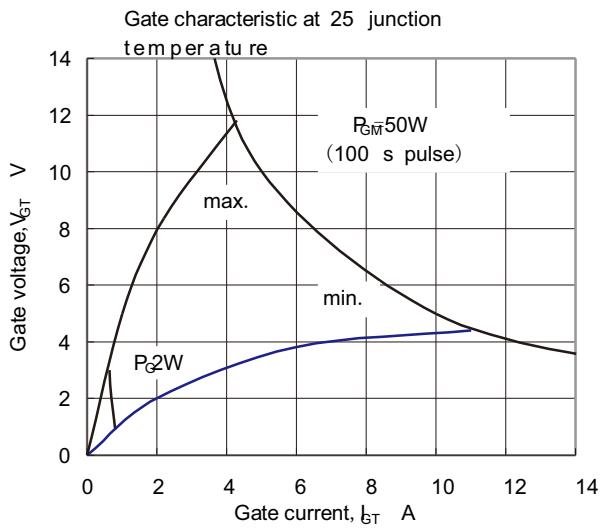

Fig. 9

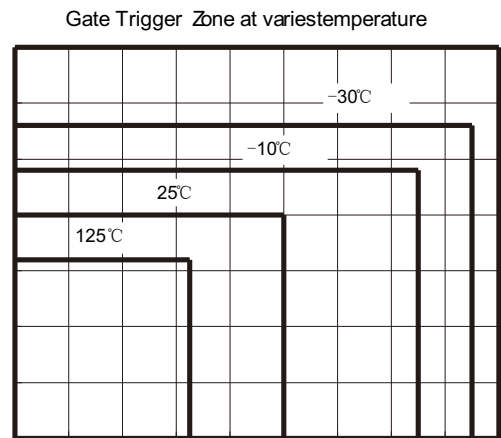

Fig. 10

Outside Dimension

