

产品规格书

Specification of Products

产品名称：三相全控桥

产品型号：MDST75A

浙江世菱电力电子有限公司

ZHEJIANG SHILING POWER ELECTRON CO.,LTD.

厂址：浙江省 缙云县 五东工业区

电话：（0578）3012571 3615078

传真：（0578）3611180

邮编：321400

E-mail:smrshiling01@163.com

Http://www.smrshiling.com

拟制	审核	核准
金明辉	曹剑龙	宗瑞

Three Phase Bridge + Thyristor

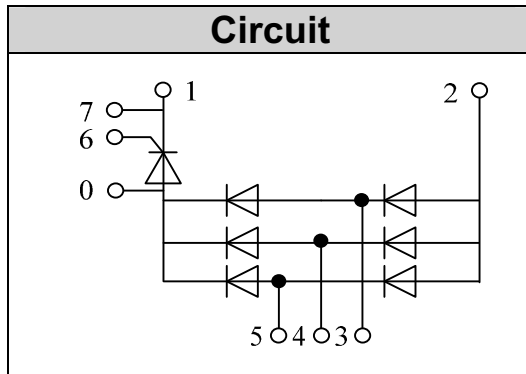

V_{RRM} / V_{DRM} 800 to 1800V
 I_{FAV} / I_{TAV} 75A

Features

- Blocking voltage:800 to 1800V
- Three Phase Bridge and a Thyristor
- Isolated Module package

Applications

- Inverter for AC or DC motor control
- Current stabilized power supply
- Switching power supply

Module Type

TYPE	V_{RRM} / V_{DRM}	V_{RSM}
MDST75A800VH3	800V	900V
MDST75A1200VH3	1200V	1300V
MDST75A1600VH3	1600V	1700V
MDST75A1800VH3	1800V	1900V

◆Diode

Maximum Ratings

Symbol	Item	Conditions	Values	Units
I_D	Output Current(D.C.)	$T_c=101^\circ\text{C}$ Three phase full wave	75	A
I_{FSM}	Surge forward current	$t=10\text{mS}$ $T_{vj}=45^\circ\text{C}$	920	A
i^2t	Circuit Fusing Consideration		4200	A^2s
Visol	Isolation Breakdown Voltage(R.M.S)	a.c.50HZ;r.m.s.;1min	3000	V
T_{vj}	Operating Junction Temperature		-40 to +150	$^\circ\text{C}$
T_{stg}	Storage Temperature		-40 to +125	$^\circ\text{C}$
M_t	Mounting Torque	To terminals(M5)	$3 \pm 5\%$	Nm
M_s		To heatsink(M5)	$3 \pm 5\%$	Nm
Weight		Module (Approximately)	210	g

Thermal Characteristics

Symbol	Item	Conditions	Values	Units
$R_{th(j-c)}$	Thermal Impedance, max.	Junction to Case(TOTAL)	0.20	$^\circ\text{C}/\text{W}$
$R_{th(c-s)}$	Thermal Impedance, max.	Case to Heatsink	0.10	$^\circ\text{C}/\text{W}$

Electrical Characteristics

Symbol	Item	Conditions	Values	Units
V_{FM}	Forward Voltage Drop, max.	$T=25^\circ\text{C}$ $I_F=100\text{A}$	1.30	V
I_{RRM}	Repetitive Peak Reverse Current, max.	$T_{vj}=25^\circ\text{C}$ $V_{RD}=V_{RRM}$ $T_{vj}=150^\circ\text{C}$ $V_{RD}=V_{RRM}$	≤ 0.5 ≤ 6	 mA mA

◆Thyristor

Maximum Ratings

Symbol	Item	Conditions	Values	Units
I_{TAV}	Average On-State Current	$T_c=99^{\circ}\text{C}$, Single Phase half wave 180° conduction	75	A
I_{TSM}	Surge On-State Current	$T_{VJ}=45^{\circ}\text{C}$ $t=10\text{ms}$ (50Hz), sine $V_R=0$	920	A
i^2t	Circuit Fusing Consideration		4200	A^2s
Visol	Isolation Breakdown Voltage(R.M.S)	a.c.50HZ;r.m.s.;1 min	3000	V
T_{vj}	Operating Junction Temperature		-40 to +125	$^{\circ}\text{C}$
T_{stg}	Storage Temperature		-40 to +125	$^{\circ}\text{C}$
M_t	Mounting Torque	To terminals(M5)	$3 \pm 5\%$	Nm
M_s		To heatsink(M5)	$3 \pm 5\%$	Nm
di/dt	Critical Rate of Rise of On-State Current	$T_{VJ}=T_{VJM}$, $V_D=1/2V_{DRM}$, $I_G=100\text{mA}$ $d_i/d_t=0.1\text{A}/\mu\text{s}$	150	$\text{A}/\mu\text{s}$
dv/dt	Critical Rate of Rise of Off-State Voltage, min.	$T_J=T_{VJM}$, $V_D=2/3V_{DRM}$, linear voltage rise	500	$\text{V}/\mu\text{s}$

Electrical and Thermal Characteristics

Symbol	Item	Conditions	Values			Units
			Min.	Typ.	Max.	
V_{TM}	Peak On-State Voltage, max.	$T=25^{\circ}\text{C}$ $I_T=100\text{A}$		1.35	V	
I_{RRM}/I_{DRM}	Repetitive Peak Reverse Current, max. / Repetitive Peak Off-State Current, max.	$T_{VJ}=T_{VJM}$, $V_R=V_{RRM}$, $V_D=V_{DRM}$		20	mA	
V_{GT}	Gate Trigger Voltage, max.	$T_{VJ}=25^{\circ}\text{C}$, $V_D=6\text{V}$		3	V	
I_{GT}	Gate Trigger Current, max.	$T_{VJ}=25^{\circ}\text{C}$, $V_D=6\text{V}$		150	mA	
Rth(j-c)	Thermal Impedance, max.	Junction to Case			0.30	$^{\circ}\text{C}/\text{W}$
Rth(c-s)	Thermal Impedance, max.	Case to Heatsink			0.10	$^{\circ}\text{C}/\text{W}$

Performance Curves

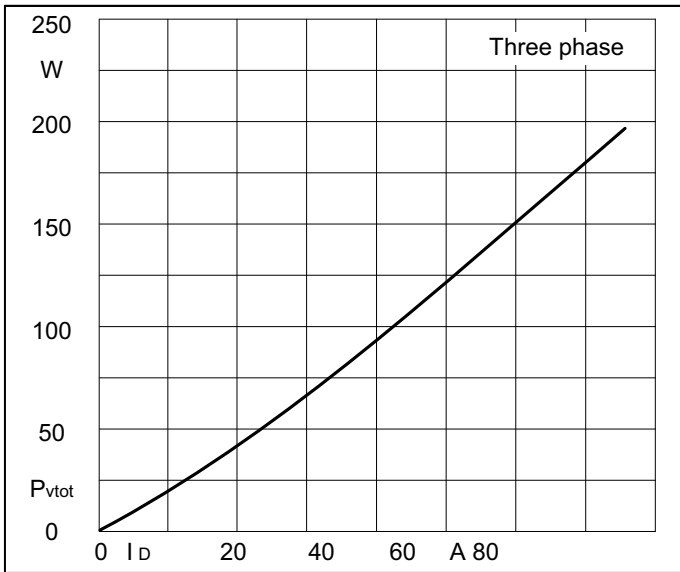

Fig1. Power dissipation

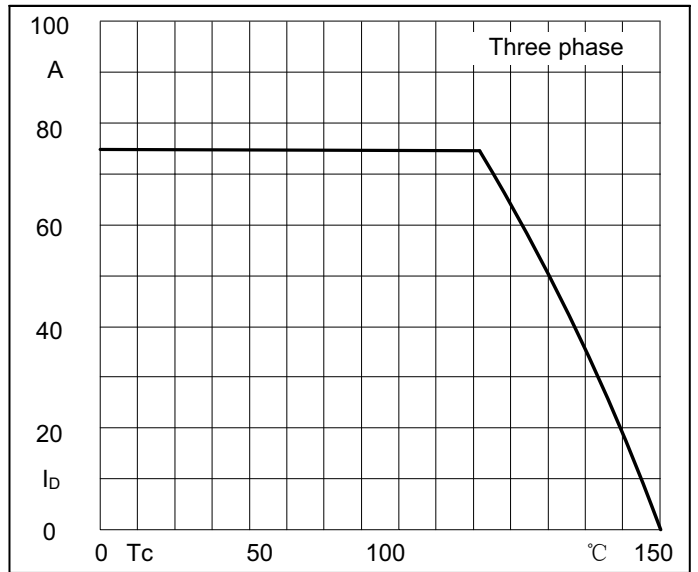

Fig2. Forward Current Derating Curve

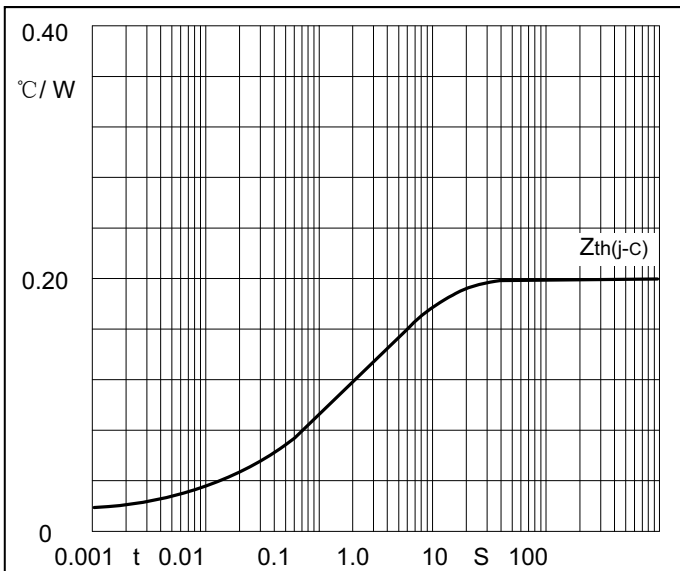

Fig3. Transient thermal impedance

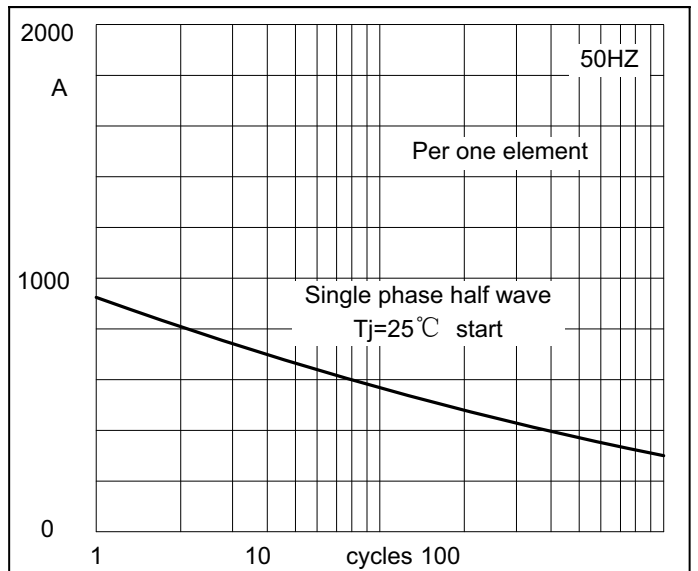

Fig4. Max Non-Repetitive Forward Surge Current

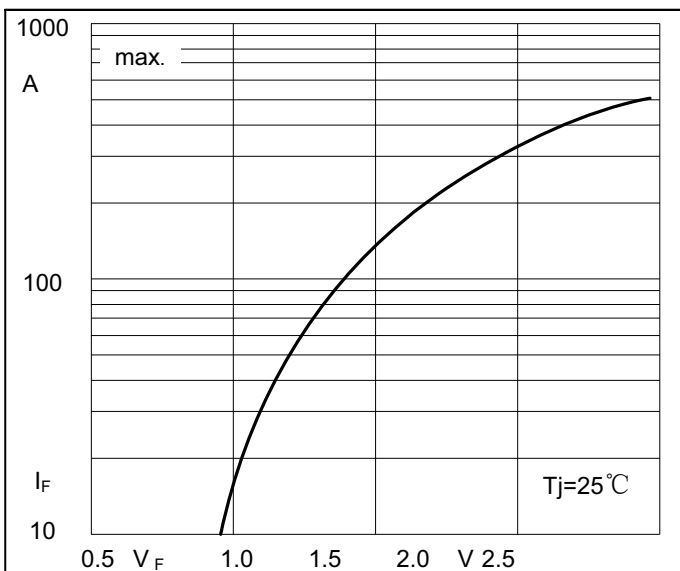

Fig5. Forward Characteristics

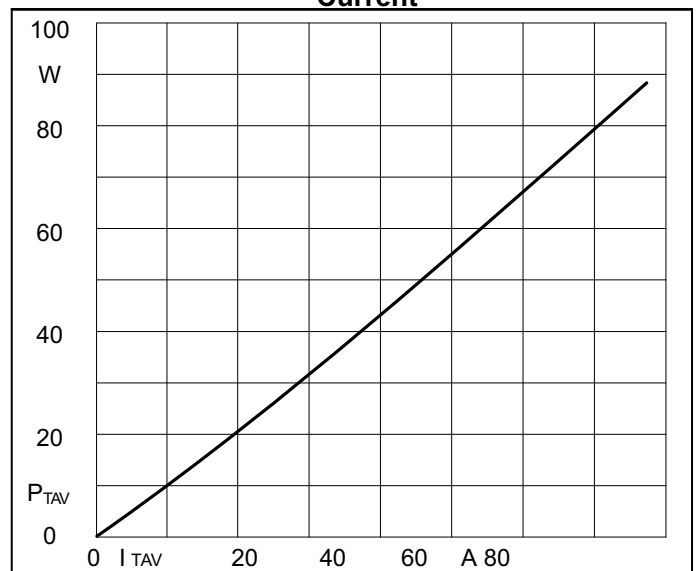

Fig6. SCR Power dissipation

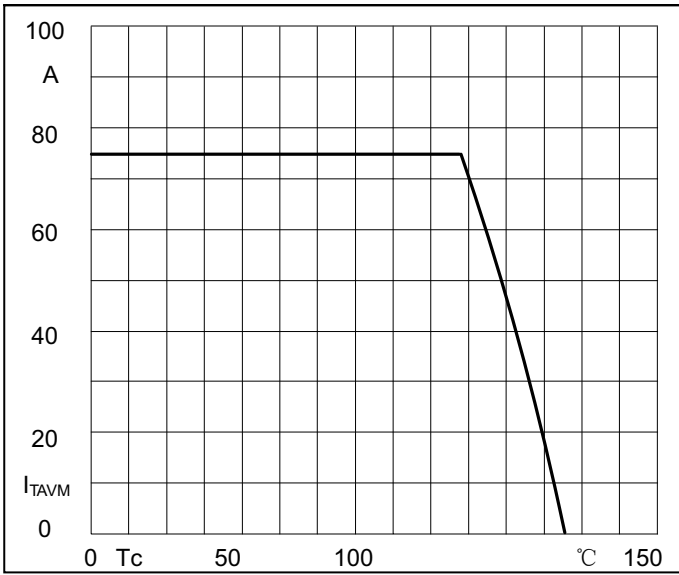

Fig7. SCR Forward Current Derating Curve

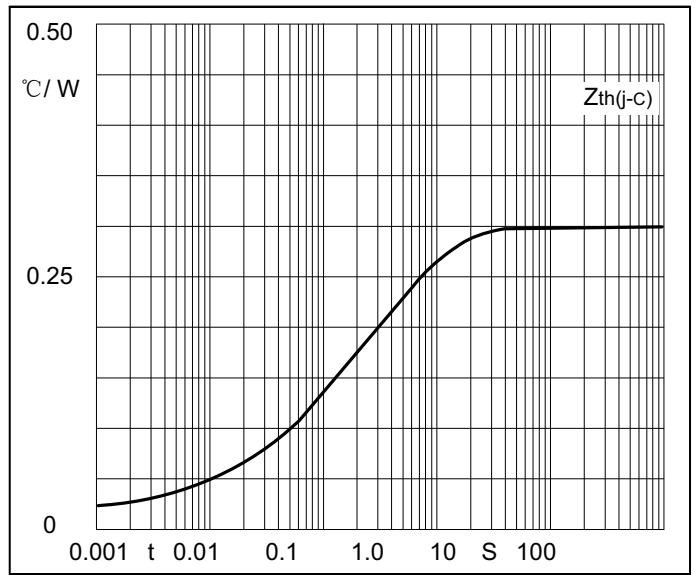

Fig8. SCR Transient thermal impedance

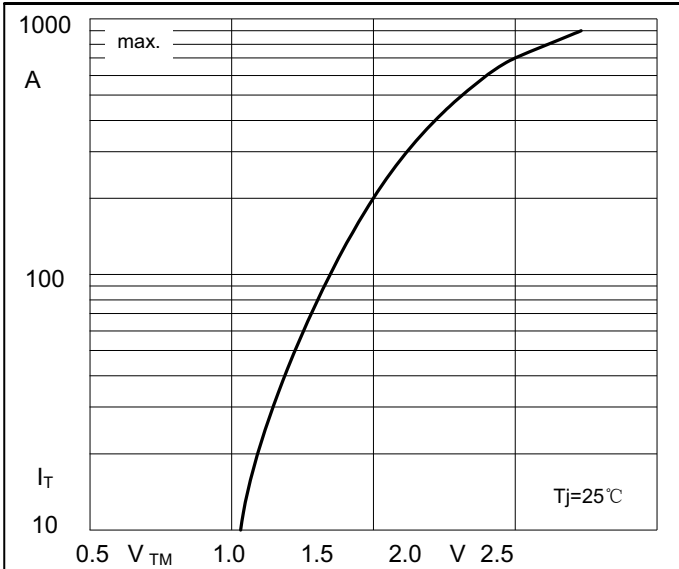

Fig9. SCR Forward Characteristics

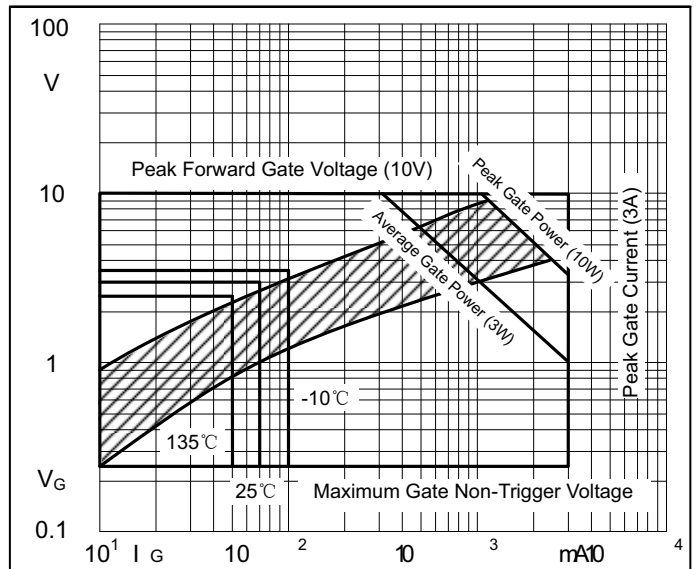
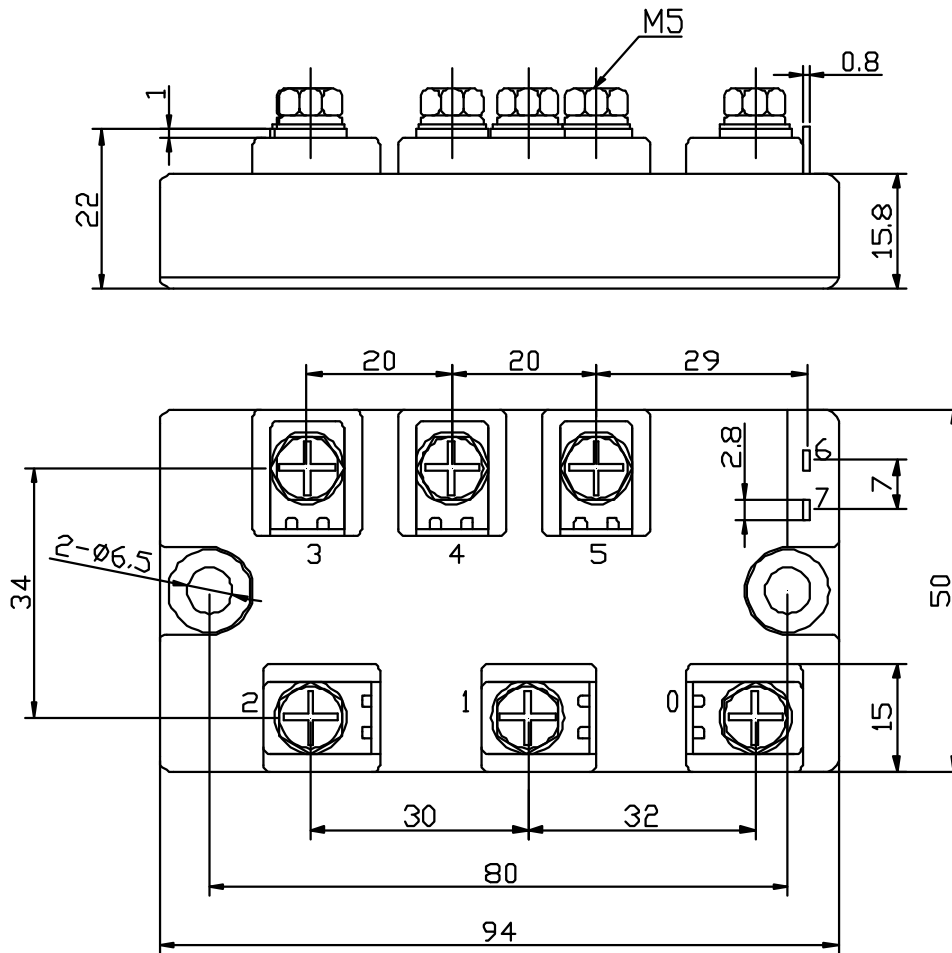

Fig10. Gate trigger Characteristics

Package Outline Information



Dimensions in mm

